

# **KERN**<sup>®</sup>

**KERN & Sohn GmbH**

Ziegelei 1

D-72336 Balingen

E-Mail: [info@kern-sohn.com](mailto:info@kern-sohn.com)

Tel: +49-[0]7433- 9933-0

Fax: +49-[0]7433-9933-149

Internet: [www.kern-sohn.com](http://www.kern-sohn.com)

## **Operating instruction Precision balances**

### **KERN EW/EG-N**

Type EG 200-3AM

Type EG 400-3AM

Type EG 600-3AM

Type EG 2000-2AM

Type EG 4000-2AM

Version 3.1

2024-05

GB



**EW/EG-N-BA-e-2431**



# KERN EW/EG-N

Version 3.1 2024-05

## Operating instruction Precision balances

### Table of contents

<b>1</b>	<b>Technical data .....</b>	<b>4</b>
1.1	Read-off of the various weighing units.....	10
1.2	Weighing unit conversion charts .....	11
<b>2</b>	<b>Fundamental information (general) .....</b>	<b>12</b>
2.1	Intended use .....	12
2.2	Inappropriate use .....	12
2.3	Guarantee.....	12
2.4	Monitoring the test substances .....	13
<b>3</b>	<b>Fundamental safety information .....</b>	<b>13</b>
3.1	Observe the information in the operating instructions.....	13
3.2	Staff training .....	13
<b>4</b>	<b>Transport and storage .....</b>	<b>13</b>
4.1	Acceptance check.....	13
4.2	Packaging / return transport .....	13
<b>5</b>	<b>Unpacking, installation and commissioning.....</b>	<b>14</b>
5.1	Place of installation, place of use .....	14
5.2	Unpacking.....	15
5.2.1	Installation .....	15
5.2.2	List of items supplied.....	15
5.2.3	Positioning the weighing plate .....	16
5.2.4	Serial draft shield installation .....	17
5.2.5	Draft shield installation – optional .....	18
5.2.6	Draft shield with glass sliding doors (only model KERN EW 120-4NM standard) .....	18
5.3	Mains supply .....	19
5.4	Operation using a rechargeable battery (optional) .....	19
5.5	Connecting peripheral equipment.....	20
5.6	Initial start-up .....	20
5.6.1	Power display .....	20
5.6.2	Bar graph display .....	20
5.6.3	Stability indication .....	21
5.6.4	Zero display on the balance .....	21
5.7	Adjustment.....	22
5.8	Adjusting .....	22
5.8.1	Adjusting with external weight (only KERN EW-N) .....	22
5.8.2	Adjusting with internal weight (only KERN EG) .....	22
5.8.3	Adjusting with external weight (only KERN EW).....	24
5.9	Verification.....	26
5.10	Verification switch and official seal .....	27
<b>6</b>	<b>Operation .....</b>	<b>28</b>
6.1	Operating elements.....	28
6.1.1	Overview of the keypad.....	29
6.1.2	Overview of display .....	30
6.2	Operation .....	31
6.2.1	Weighing .....	31
6.2.1.1	Underfloor weighing.....	32
6.2.1.2	Tare weighing (tare) .....	33

6.2.2	Piece counting (excl. model KERN EW120-4NM) .....	35
6.2.2.1	Add mode .....	37
6.2.3	Percent weighing (excl. model KERN EW120-4NM) .....	39
6.2.4	Weighing using a tolerance range (excl. model KERN EW120-4NM) .....	40
6.2.4.1	Basic settings when weighing using a tolerance range .....	41
6.2.4.2	Entering the limit values by weighing.....	43
6.2.4.3	Entering the limit values using the keyboard .....	45
<b>7</b>	<b>Functions .....</b>	<b>47</b>
7.1	<b>Access and changing of numerous functions:.....</b>	<b>47</b>
7.2	<b>List of the function parameters .....</b>	<b>48</b>
7.2.1	Parameters when weighing with a tolerance range (excl. model KERN EW120-4NM).....	50
7.2.2	Parameters for the serial interface .....	51
7.2.3	Show software status .....	52
<b>8</b>	<b>Data output .....</b>	<b>53</b>
8.1	<b>Description of the serial data output (RS 232C) .....</b>	<b>53</b>
8.2	<b>Technical data of the interface .....</b>	<b>53</b>
8.3	<b>Interface description.....</b>	<b>54</b>
8.4	<b>Data Output.....</b>	<b>54</b>
8.4.1	Data Transmission Formats .....	54
8.4.2	Algebraic sign.....	55
8.4.3	Data.....	55
8.4.4	Units .....	56
8.4.5	Result of the evaluation / Type of data .....	56
8.4.6	Data state .....	56
8.5	<b>Data input commands.....</b>	<b>57</b>
8.5.1	Command input format.....	57
8.5.2	External taring command .....	57
8.5.3	External control commands.....	57
8.6	<b>Feedback message after data transmission .....</b>	<b>58</b>
<b>9</b>	<b>Maintenance, upkeep, disposal.....</b>	<b>58</b>
9.1	<b>Cleaning .....</b>	<b>58</b>
9.2	<b>Maintenance, upkeep.....</b>	<b>58</b>
9.3	<b>Disposal .....</b>	<b>58</b>
<b>10</b>	<b>Troubleshooting.....</b>	<b>59</b>
<b>11</b>	<b>Declaration of Conformity .....</b>	<b>60</b>

## 1 Technical data

KERN (Type)	EG 200-3AM	EG 400-3AM	EG 600-3AM
Model	EG 220-3NM	EG 420-3NM	EG 620-3NM
Readout	0,001 g	0,001 g	0,001 g
Verification value (e)	0,01 g	0,01 g	0,01 g
Weighing range (max.)	220 g	420 g	620 g
Class of accuracy	II	II	I
Taring range (subtractive)	220g	420 g	620 g
Minimum load (Min)	0,02 g	0,02 g	0,1 g
Minimum weight for counting parts	0,001 g	0,001 g	0,001 g
Reference quantity	10, 30, 50, 100	10, 30, 50, 100	10, 30, 50, 100
Minimum unit weight at piece counting under laboratory conditions*	0,001 g	0,001 g	0,001 g
Minimum unit weight at piece counting under normal conditions**	0,01 g	0,01 g	0,01 g
Reproducibility	0,001 g	0,001 g	0,001 g
Linearity	± 0,002 g	± 0,003 g	± 0,004 g
Adjusting weight	internal	internal	internal
Stabilization time	3 sec.	3 sec.	3 sec.
Weighing plate stainless steel	Ø 118 mm	Ø 118 mm	Ø 118 mm
Weight kg (net)	2,0	2,0	2,0
Units, verification switch in verification position,(chap. 5.10)	g, ct		
Units , verification switch not in verification position, (chap. 5.10)	g, ct, oz, lb, ozt, dwt, GN, tl (HongKong), tl (Taiwan), tl (Singapore, Malaysia), momme, tola		
Air humidity	max. 80 % relative (not condensing)		
Permissible ambient condition	10° C to 30° C		
Balance dimensions	235 x 180 x 75 mm (excluding draft shield) 235 x 185 x 165 mm (including draft shield)		
Vibratory filter	4		
Mains supply	Mains adaptor 100-240 V AC, 50/60 Hz ; 12 V DC balance, 1A		
Interface	RS 232 C interfaced		
Rechargeable battery	optional; 6 V DC, 2000 mAh		
Underfloor weighing	Hanging loop optional		
Altitude	Up to 2000 m		
Pollution Degree	2		
Installation Site	device may only be used indoors		

<b>KERN (Type)</b>	<b>EG 2000-2AM</b>	<b>EG 4000-2AM</b>
Model	EG 2200-2NM	EG 4200-2NM
Readout	0,01 g	0,01 g
Verification value (e)	0,1 g	0,1 g
Weighing range (max.)	2200 g	4200 g
Class of accuracy	II	II
Taring range (subtractive)	2200 g	4200 g
Minimum load (Min)	0,5 g	0,5 g
Minimum weight for counting parts	0,01 g	0,01 g
Reference quantity	10, 30, 50, 100	10, 30, 50, 100
Minimum unit weight at piece counting under laboratory conditions*	0,01 g	0,01 g
Minimum unit weight at piece counting under normal conditions**	0,1 g	0,1 g
Reproducibility	0,01 g	0,01 g
Linearity	± 0, 02 g	± 0,02 g
Adjusting weight	internal	internal
Test weight, included	-	-
Recommended adjusting weight, not included (class)	-	-
Stabilization time	3 sec.	3 sec.
Weighing plate stainless steel	180 x 160 mm	180 x 160 mm
Weight kg (net)	3,7	3,7
Units, verification switch in verification position,(chap. 5.10)	g, ct	
Units , verification switch not in verification position, (chap. 5.10)	g, ct, oz, lb, ozt, dwt, GN, tl (HongKong), tl (Taiwan), tl (Singapore, Malaysia), momme, tola	
Air humidity	max. 80 % relative (not condensing)	
Permissible ambient condition	10° C to 30° C	
Balance dimensions excluding draft shield	190 x 265 x 90 mm	
Vibratory filter	4	
Mains supply	Mains adaptor 100-240 V AC, 50/60 Hz ; 12 V DC balance, 1A	
Interface	RS 232 C interfaced	
Rechargeable battery	optional; 6 V DC, 2000 mAh	
Underfloor weighing	Hanging loop optional	
Altitude	Up to 2000 m	
Pollution Degree	2	
Installation Site	device may only be used indoors	

<b>KERN</b>	<b>EW 220-3NM</b>	<b>EW 420-3NM</b>	<b>EW 620-3NM</b>
Readout	0,001 g	0,001 g	0,001 g
Verification value (e)	0,01 g	0,01 g	0,01 g
Weighing range (max.)	220 g	420 g	620 g
Class of accuracy	II	II	I
Taring range (subtractive)	220g	420 g	620 g
Minimum load (Min)	0,02 g	0,02 g	0,1 g
Minimum weight for counting parts	0,001 g	0,001 g	0,001 g
Reference quantity	10, 30, 50, 100	10, 30, 50, 100	10, 30, 50, 100
Minimum unit weight at piece counting under laboratory conditions*	0,001 g	0,001 g	0,001 g
Minimum unit weight at piece counting under normal conditions**	0,01 g	0,01 g	0,01 g
Reproducibility	0,001 g	0,001 g	0,001 g
Linearity	± 0,002 g	± 0,003 g	± 0,004 g
Recommended adjusting weight, not included (class)	200g (F1)	2 x 200g (E2)	500 g (E2)
Stabilization time	2 sec.	2 sec.	2 sec.
Weighing plate stainless steel	Ø 118 mm	Ø 118 mm	Ø 118 mm
Weight kg (net)	1,3	1,3	1,3
Units, verification switch in verification position,(chap. 5.10)	g, ct		
Units , verification switch not in verification position, (chap. 5.10)	g, ct, oz, lb, ozt, dwt, GN, tl (HongKong), tl (Taiwan), tl (Singapore, Malaysia), momme, tola		
Air humidity	max. 80 % relative (not condensing)		
Permissible ambient condition	10° C to 30° C		
Balance dimensions	235 x 180 x 75 mm (excluding draft shield) 235 x 185 x 165 mm (including draft shield)		
Vibratory filter	4		
Mains supply	Mains adaptor 100-240 V AC, 50/60 Hz ; 12 V DC balance, 1A		
Interface	RS 232 C interfaced		
Rechargeable battery	optional; 6 V DC, 2000 mAh		
Underfloor weighing	Hanging loop optional		
Altitude	Up to 2000 m		
Pollution Degree	2		
Installation Site	device may only be used indoors		

<b>KERN</b>	<b>EW 820-2NM</b>	<b>EW 2200-2NM</b>	<b>EW 4200-2NM</b>
Readout	0,01 g	0,01 g	0,01 g
Verification value (e)	0,01 g	0,1 g	0,1 g
Weighing range (max.)	820 g	2200 g	4200 g
Class of accuracy	I	II	II
Taring range (subtractive)	820 g	2200 g	4200 g
Minimum load (Min)	1 g	0,5 g	0,5 g
Minimum weight for counting parts	0,01 g	0,01 g	0,01 g
Reference quantity	10, 30, 50, 100	10, 30, 50, 100	10, 30, 50, 100
Minimum unit weight at piece counting under laboratory conditions*	0,01 g	0,01 g	0,01 g
Minimum unit weight at piece counting under normal conditions**	0,1 g	0,1 g	0,1 g
Reproducibility	0,01 g	0,01 g	0,01 g
Linearity	± 0,01 g	± 0,01 g	± 0,02 g
Recommended adjusting weight, not included (class)	1 x 200 g + 1 x 500 g(F1)	2000 g (F1)	2 x 2 kg (E2)
Stabilization time	2 sec.	2 sec.	2 sec.
Weighing plate stainless steel	170 x 142 mm	180 x 160 mm	180 x 160 mm
Weight kg (net)	1,3	2,8	2,8
Units, verification switch in verification position,(chap. 5.10)	g, ct		
Units , verification switch not in verification position, (chap. 5.10)	g, ct, oz, lb, ozt, dwt, GN, tl (HongKong), tl (Taiwan), tl (Singapore, Malaysia), momme, tola		
Air humidity	max. 80 % relative (not condensing)		
Permissible ambient condition	10° C to 30° C		
Balance dimensions excluding draft shield	180 x 235 x 75 mm	190 x 265 x 90 mm	
Vibratory filter	4		
Mains supply	Mains adaptor 100-240 V AC, 50/60 Hz ; 12 V DC balance, 1A		
Interface	RS 232 C interfaced		
Rechargeable battery	optional; 6 V DC, 2000 mAh		
Underfloor weighing	Hanging loop optional		
Altitude	Up to 2000 m		
Pollution Degree	2		
Installation Site	device may only be used indoors		

<b>KERN</b>	<b>EW 6200-2NM</b>	<b>EW 12000-1NM</b>
Readout	0,01 g	0,1 g
Verification value (e)	0,1 g	1 g
Weighing range (max.)	6 200 g	12 000 g
Class of accuracy	I	II
Taring range (subtractive)	6 200 g	12 000 g
Minimum load (Min)	1 g	5 g
Minimum weight for counting parts	0,01 g	0,1 g
Reference quantity	10, 30, 50, 100	10, 30, 50, 100
Minimum unit weight at piece counting under laboratory conditions*	0,01 g	0,1 g
Minimum unit weight at piece counting under normal conditions**	0,1 g	1 g
Reproducibility	0,02 g	0,1 g
Linearity	± 0, 03 g	± 0,1 g
Recommended adjusting weight, not included (class)	5 kg (E2)	10 kg (F1)
Stabilization time	3 sec.	3 sec.
Weight kg (net)	2,8	2,8
Units, verification switch in verification position,(chap. 5.10)	g, ct	
Units , verification switch not in verification position, (chap. 5.10)	g, ct, oz, lb, ozt, dwt, GN, tl (HongKong), tl (Taiwan), tl (Singapore, Malaysia), momme, tola	
Air humidity	max. 80 % relative (not condensing)	
Permissible ambient condition	10° C to 30° C	
Weighing plate stainless steel	180 x 160 mm	
Balance dimensions	190 x 265 x 90 mm (excluding draft shield)	
Vibratory filter	4	
Mains supply	Mains adaptor 100-240 V AC, 50/60 Hz ; 12 V DC balance, 1A	
Interface	RS 232 C interfaced	
Rechargeable battery	optional; 6 V DC, 2000 mAh	
Underfloor weighing	Hanging loop optional	
Altitude	Up to 2000 m	
Pollution Degree	2	
Installation Site	device may only be used indoors	



**\* Minimum unit weight at piece counting under laboratory conditions:**

- Perfect ambient conditions to perform high resolution counting
- No dispersion of counted parts weight

**\*\*Minimum unit weight at piece counting under normal conditions:**

- Unstable ambient conditions (wind gusts, vibrations)
- Dispersion of counted parts weight

## 1.1 Read-off of the various weighing units

Weighing unit	EG 220-3NM / EW 220-3NM	EG 420-3NM / EW 420-3NM
<b>g</b>	0.001	0.001
<b>ct</b> (ct)	0.01	0.01
<b>oz</b> (oz)	0.0001	0.0001
<b>lb</b> (lb)	0.00001	0.00001
<b>oz t</b> (ozt)	0.0001	0.0001
<b>dwt</b> (dwt)	0.001	0.001
<b>grain</b> (grain)	0.1	0.1
<b>t</b> (Hong Kong)	0.0001	0.0001
<b>t</b> (Singapore, Malaysia)	0.0001	0.0001
<b>t</b> (Taiwan)	0.0001	0.0001
<b>mom</b>	0.001	0.001
<b>to</b> (to)	0.0001	0.0001

Weighing unit	EG 620-3NM / EW 620-3NM	EW 820-2NM	EG 2200-2NM/ EW 2200-2NM
<b>g</b>	0.001	0.01	0.01
<b>ct</b> (ct)	0.01	0.05	0.1
<b>oz</b> (oz)	0.0001	0.0005	0.001
<b>lb</b> (lb)	0.00001	0.00005	0.0001
<b>oz t</b> (ozt)	0.0001	0.0005	0.001
<b>dwt</b> (dwt)	0.001	0.01	0.01
<b>t</b> (Hong Kong)	0.1	0.0005	0.001
<b>t</b> (Singapore, Malaysia)	0.0001	0.0005	0.001
<b>t</b> (Taiwan)	0.0001	0.0005	0.001
<b>mom</b>	0.0001	0.005	0.01
<b>to</b> (to)	0.001	0.001	0.001
	0.0001		

Weighing unit	EG 4200-2NM/ EW 4200-2NM	EW 6200-2NM	EW 12000-1NM
<b>g</b>	0.01	0.01	0.1
<b>ct</b> (ct)	0.1	0.1	1
<b>oz</b> (oz)	0.001	0.001	0.01
<b>lb</b> (lb)	0.0001	0.0001	0.001
<b>oz t</b> (ozt)	0.001	0.001	0.01
<b>dwt</b> (dwt)	0.01	0.01	0.1
<b>t</b> (Hong Kong)	0.001	0.001	0.01
<b>t</b> (Singapore, Malaysia)	0.001	0.001	0.01
<b>t</b> (Taiwan)	0.001	0.001	0.01
<b>mom</b>	0.01	0.01	0.1
<b>to</b> (to)	0.001	0.001	0.01

## 1.2 Weighing unit conversion charts

Weighing unit	Gramm	Carat	Ounze	Pound	Fine ounce	Penny weight
1g	1	5	0.03527	0.00220	0.03215	0.64301
1ct	0.2	1	0.00705	0.00044	0.00643	0.12860
1oz	28.34952	141.74762	1	0.06250	0.91146	18.22917
1lb	453.59237	2267.96185	16	1	14.58333	291.66667
1ozt	31.10348	155.51738	1.09714	0.06857	1	20
1dwt	1.55517	7.77587	0.05486	0.00343	0.05	1
1GN	0.06480	0.32399	0.00229	0.00014	0.00208	0.04167
1tl (HK)	37.429	187.145	1.32027	0.08252	1.20337	24.06741
1tl (SGP, Mal)	37.79936	188.99682	1.33333	0.08333	1.21528	24.30556
1tl (Taiwan)	37.5	187.5	1.32277	0.08267	1.20565	24.11306
1mom	3.75	18.75	0.13228	0.00827	0.12057	2.41131
1to	11.66380	58.31902	0.41143	0.02571	0.37500	7.5

Weighing unit	Grain	Tael (Hong Kong)	Tael (Singapore, Malaysia)	Tael (Taiwan)	Momme	Tola
1g	15.43236	0.02672	0.02646	0.02667	0.26667	0.08574
1ct	3.08647	0.00534	0.00529	0.00533	0.05333	0.01715
1oz	437.5	0.75742	0.75	0.75599	7.55987	2.43056
1lb	7000	12.11874	12	12.09580	120.95797	38.88889
1ozt	480	0.83100	0.82286	0.82943	8.29426	2.66667
1dwt	24	0.04155	0.04114	0.04147	0.41471	0.13333
1GN	1	0.00173	0.00171	0.00173	0.01728	0.00556
1tl (HK)	577.61774	1	0.99020	0.99811	9.98107	3.20899
1tl (SGP, Mal)	583.33333	1.00990	1	1.00798	10.07983	3.24074
1tl (Taiwan)	578.71344	1.00190	0.99208	1	10	3.21507
1mom	57.87134	0.10019	0.09921	0.1	1	0.32151
1to	180	0.31162	0.30857	0.31103	3.11035	1

## 2 Fundamental information (general)

### 2.1 Intended use

The balance you have acquired serves to determine the weighing value of the material to be weighed. It is intended to be used as a “non-automatic” balance, i.e. the material to be weighed is manually and carefully placed in the centre of the weighing plate. The weighing value can be read off after a stable weighing value has been obtained.

### 2.2 Inappropriate use

Do not use the balance for dynamic weighing. In the event that small quantities are removed or added to the material to be weighed, incorrect weighing results can be displayed due to the “stability compensation” in the balance. (Example: Slowly draining fluids from a container on the balance.)

Do not leave a permanent load on the weighing plate. This can damage the measuring equipment.

Be sure to avoid impact shock and overloading the balance in excess of the prescribed maximum load rating (max.), minus any possible tare weight that is already present. This could cause damage to the balance.

Never operate the balance in hazardous locations. The series design is not explosion-proof.

Structural alterations may not be made to the balance. This can lead to incorrect weighing results, faults concerning safety regulations as well as to destruction of the balance.

The balance may only be used in compliance with the described guidelines. Varying areas of application/planned use must be approved by KERN in writing.

### 2.3 Guarantee

The guarantee is not valid following

- non-observation of our guidelines in the operating instructions
- use outside the described applications
- alteration to or opening of the device
- mechanical damage and damage caused by media, liquids
- natural wear and tear
- inappropriate erection or electric installation
- overloading of the measuring equipment

## 2.4 Monitoring the test substances

The metrology features of the balance and any possible available adjusting weight must be checked at regular intervals within the scope of quality assurance. For this purpose, the answerable user must define a suitable interval as well as the nature and scope of this check. Information is available on KERN's home page ([www.kern-sohn.com](http://www.kern-sohn.com)) with regard to the monitoring of balance test substances and the test weights required for this. Test weights and balances can be adjusted quickly and at a reasonable price in KERN's accredited DKD calibration laboratory (return to national normal).

## 3 Fundamental safety information

### 3.1 Observe the information in the operating instructions

Please read the operating instructions carefully before erecting and commissioning, even if you already have experience with KERN balances.

### 3.2 Staff training

The device may only be operated and looked after by trained members of staff.

## 4 Transport and storage

### 4.1 Acceptance check

Please check the packaging immediately upon delivery and the device during unpacking for any visible signs of external damage.

### 4.2 Packaging / return transport



- ⇒ Keep all parts of the original packaging for a possibly required return.
- ⇒ Only use original packaging for returning.
- ⇒ Prior to dispatch disconnect all cables and remove loose/mobile parts.
- ⇒ Reattach possibly supplied transport securing devices.
- ⇒ Secure all parts such as the glass wind screen, the weighing platform, power unit etc. against shifting and damage.

## 5 Unpacking, installation and commissioning

### 5.1 Place of installation, place of use

The balance is constructed in such a way that reliable weighing results can be achieved under normal application conditions.

By selecting the correct location for your balance, you will be able to work quickly and precisely.

**Therefore please observe the following at the place of installation:**

- Place the balance on a firm, level surface;
- Avoid extreme heat as well as temperature fluctuation caused by installing next to a radiator or in the direct sunlight;
- Protect the balance against direct draughts due to open windows and doors;
- Avoid jarring during weighing;
- Protect the balance against high humidity, vapours and dust;
- Do not expose the device to extreme dampness for longer periods of time. Inadmissible bedewing (condensation of air moisture on the device) can occur if a cold device is taken into a significantly warmer environment. In this case, please acclimatise the device for approx. 2 hours at room temperature after it has been disconnected from the mains.
- Avoid static charging of the material to be weighed, weighing container and windshield.

Major display deviations (incorrect weighing results) are possible if electromagnetic fields occur as well as due to static charging and instable power supply. It is then necessary to change the location.

## 5.2 Unpacking

Carefully remove the balance from its packaging, remove the plastic wrapping and position the balance in its intended working location.

### 5.2.1 Installation

Use the foot screws to level the balance until the air bubble in the bubble level is in the prescribed circle.

### 5.2.2 List of items supplied

#### **Standard accessories:**

(1) Balance



(2) Weighing plate

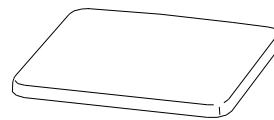

(3) Weighing plate bracket

(4) Windbreak

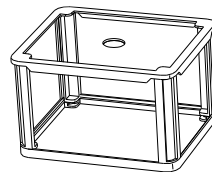
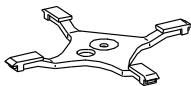

(5) Operating instructions

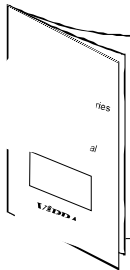

(6) Mains adaptor

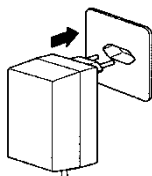

### 5.2.3 Positioning the weighing plate

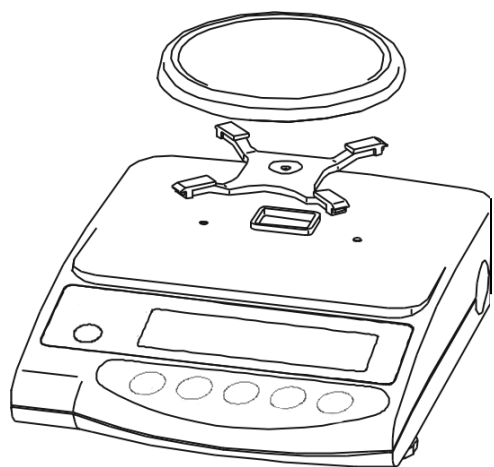

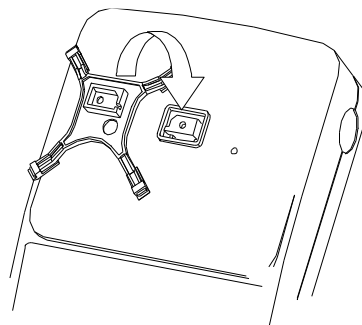

Screw the bracket on tightly according to the drawing and subsequently attach the weighing plate.



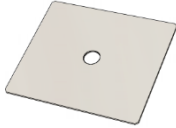
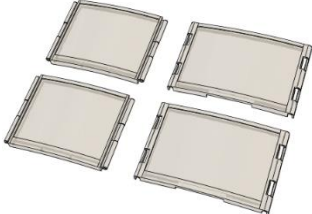
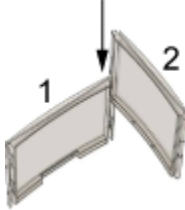
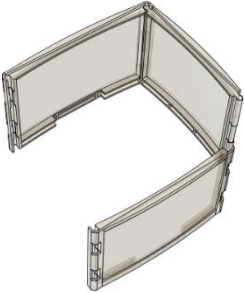

**5.2.4 Serial draft shield installation  
(Only for models with readout d = 0,001 g standard)**

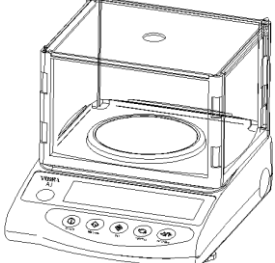
	
<p>Cover</p>	<p>Sides (2 large, 2 small)</p>
<p>Slide the small side (1) into the large side (2)</p>	
<p>Properly attach another large side to both sides.</p>	
<p>Install the fourth side as shown in the figure.</p>	
<p>Put the cover on the assembled sides.</p>	

### 5.2.5 Draft shield installation – optional

Remove the weighing plate and loosen the screws to remove the bracket. Use a screwdriver to loosen both screws to the left and right of the bracket guide and remove.

Now place the draft shield to fit on the housing and secure through the opened sliding doors using both screws.

Screw the bracket on tightly according to the drawing and subsequently attach the weighing plate.

### 5.2.6 Draft shield with glass sliding doors

(only model KERN EW 120-4NM standard)

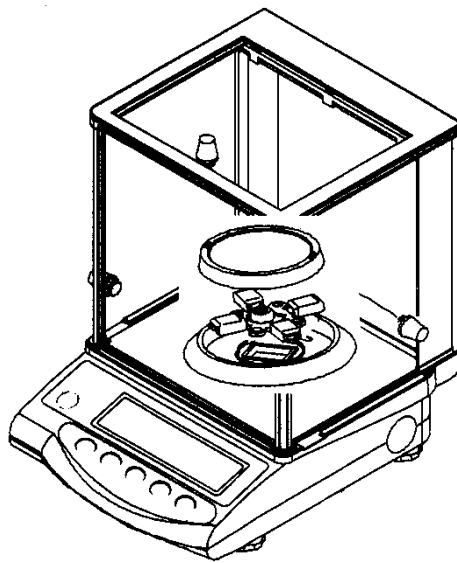

### 5.3 Mains supply

Electric power supply is by means of the external mains supply circuit. The printed voltage level must comply with the local voltage.

Only use original KERN mains supply circuits. The use of other makes is subject to approval by KERN.

#### Mains adaptor connection:

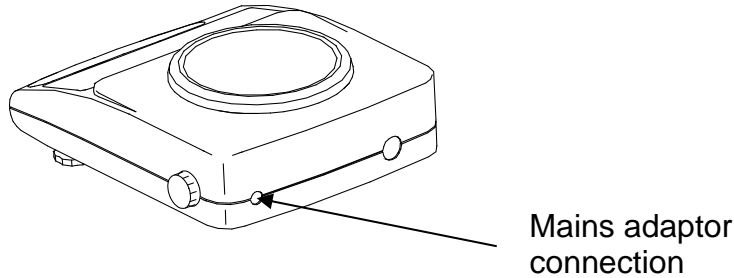

### 5.4 Operation using a rechargeable battery (optional)

Take off the weighing plate and remove the bracket by loosening the screw. Use a screwdriver to loosen both screws to the left and right of the bracket guide and remove.

Release both retaining hooks on the lower housing section and carefully remove the lower housing section to the rear (please observe the upper housing section guides on the back of the balance).

Loosen and remove both fastening screws as shown on the illustration.

Remove the rechargeable battery from the packaging and **begin by connecting the electric power supply to the circuit board of the rechargeable battery.**

Subsequently set up the plug-in connection to the computer circuit board of the balance (CN5).

The rechargeable battery is placed on the left side of the housing in such a way that it can be screwed onto the balance through the existing mounting using the screw loosened previously. Press lightly into the housing prior to this, (there is only one correct installation possibility). Now also re-attach the display using the loosened screw.

Place the upper housing section on the rear guides and tilt forward until both retaining hooks on the lower housing section audibly lock into place.

Screw down both screws to the left and right of the bracket guide tightly and re-secure the bracket. Attach the weighing plate.

#### Information:

Though the rechargeable battery is immediately operative, it should be charged for at least 8 hours using the mains adaptor before being used for the first time.

## 5.5 Connecting peripheral equipment

The balance must be disconnected from the mains before connecting or disconnecting additional equipment (printer, PC) to or from the data interface (see chap. 8.)

Only use KERN accessories and peripheral equipment with your balance. These have been ideally coordinated to your balance.

## 5.6 Initial start-up

A warm-up time of 10 minutes stabilises the measured values after switching on.

The accuracy of the balance depends on the local acceleration of the fall.

Please be sure to observe the information in the chapter on adjusting (chap. 5.7).

### 5.6.1 Power display

If the (\*) sign can be seen, the balance is being supplied with power via the mains adaptor. The balance is in weighing mode when the  key is operated.



The power display is then no longer to be seen on the display overview.

### 5.6.2 Bar graph display

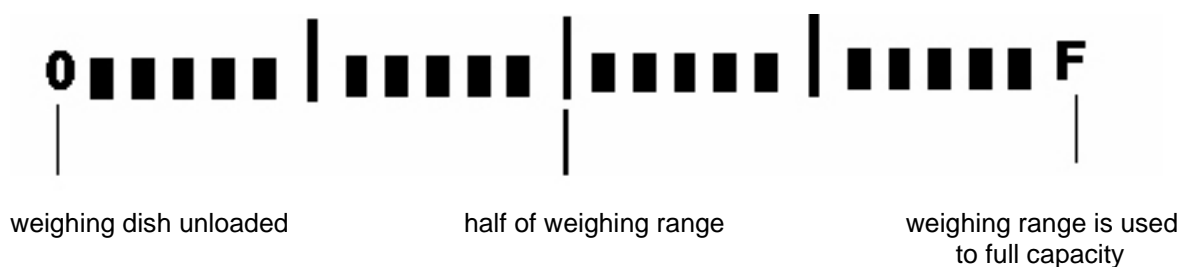

The weighing range of the balance is divided into 20 graphic cuboids. Zero (0) will appear on the graphic display if there is no weighing value on the balance. 10 graphic cuboids are displayed if the balance is loaded up to one half of its weighing range.

#### Information:

If tare weighing is being carried out, the graphic weight display will continue to indicate the number of cuboids of the tare weight.

### 5.6.3 Stability indication

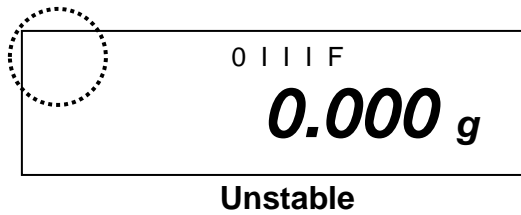
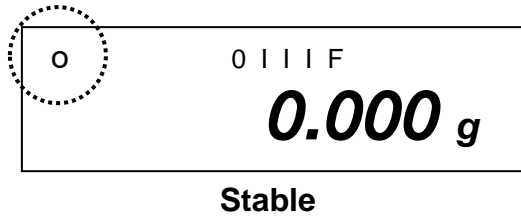



The balance is in a stable condition if the [o] stability indication appears on the display. The [o] indication disappears if the condition is unstable. Stable ambient conditions can be achieved by using the draft shield (See chap. 5.2.4 for installation)

### 5.6.4 Zero display on the balance

Environmental influences can lead to the exact figure of “**0.000**” not being displayed in spite of an empty weighing dish. It is, however, possible to reset your balance to zero at any time and thus ensure that weighing really does commence at zero. Setting to zero when a weight is applied is only possible within a certain type-dependent range. In the event that the balance cannot be reset to zero with an applied weight, this range has been exceeded.

[o - Err ] will appear on the display.

Operation	Display
If an exact zero reading is not displayed on the balance in spite of the weighing dish being empty, press the  key and the balance will start resetting to zero.	
Your balance will be set to zero after a short standby time. In addition to this, the sign for the balance zero setting will be displayed [ <b>→0←</b> ].	

## 5.7 Adjustment

As the acceleration value due to gravity is not the same at every location on earth, each balance must be coordinated – in compliance with the underlying physical weighing principle - to the existing acceleration due to gravity at its place of location ( only if the balance has not already been adjusted to the location in the factory). This adjustment process must be carried out at every start-up, after every change of location as well as in case of fluctuating environment temperature. It is also recommendable to adjust the balance periodically during weighing operation in order to obtain exact measured values.

## 5.8 Adjusting

### 5.8.1 Adjusting with external weight (only KERN EW-N)

For verified balances the verification switch is locked (except for class of accuracy I). In order to proceed with the verification, please unlock the verification switch (except for class of accuracy I).

### 5.8.2 Adjusting with internal weight (only KERN EG)

Adjust the balance prior to any start-up.

If the supply voltage is disconnected, the scale must be calibrated.

It is not possible to use the scale without prior adjustment.

Using a precision weight, the accuracy of the balance can be checked at any time and adjusted.

#### Adjustment procedure:

Check that the surrounding conditions are stable.

A short warm-up time of about 10 minutes is recommended for stabilisation.

Operation	Display
Switch-on balance with button  , after a short time [ <b>S.A. CAL</b> ] will appear.	<div style="border: 1px solid black; padding: 10px; width: fit-content; margin: 0 auto;"> <p><b>S.A. CAL</b></p> </div>

Press buttons **F** and **TARE** at the same time and release at the same time, **[WAI*t*]** is briefly displayed.

After that **[CAL.0]** will appear flashing, Zero point will be saved.

After that **[CAL.on]** will appear.

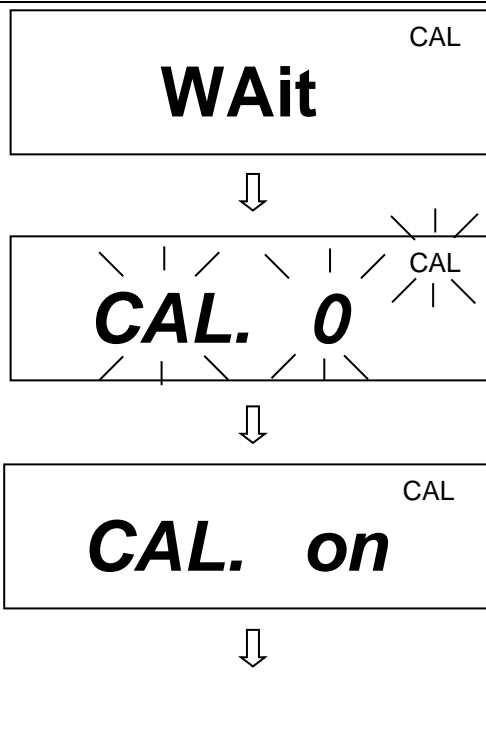

Rotate the turn knob on the right side of the balance in to position **CAL**.

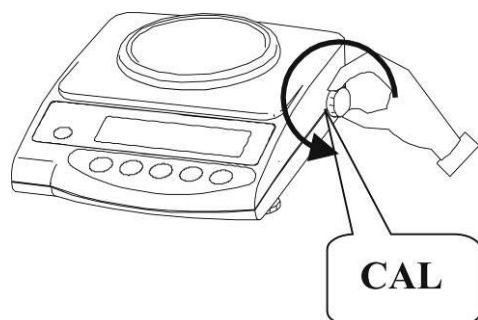

Adjustment is carried out automatically. **[CAL.on]** will appear flashing.



The display changes automatically from **[CAL.on]** to **[CAL.off]**

The process of adjustment is completed.



Turn the adjusting knob on the right side of the balance to the **WEIGH** position.

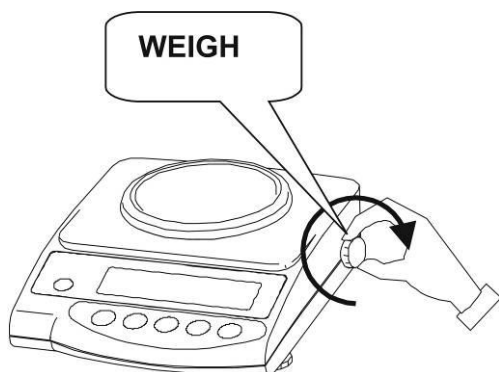

Calibration is now finalised.

The balance will automatically return to weighing mode.

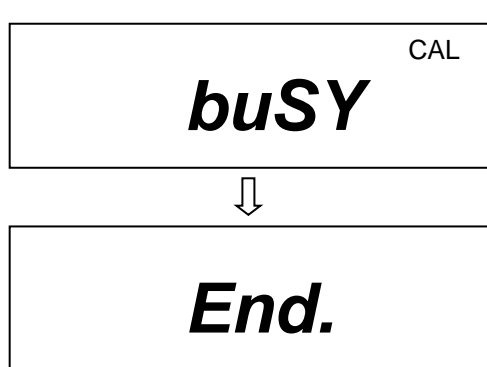

### 5.8.3 Adjusting with external weight (only KERN EW)

Carry out adjustment with the recommended adjusting weight (see Chapter 1 „Technical Data“). The adjustment can also be carried out with different adjusting weights (see table), but not ideal from a metrological point of view. Information concerning the adjusting weights is available at: <http://www.kern-sohn.com>







Model	Alternative adjusting weight
EW 220-3NM	100 g
EW 420-3NM	100 g
EW 620-3NM	200 g
EW 820-2NM	200 g
EW 2200-2NM	500 g
EW 4200-2NM	1000 g
EW 6200-2NM	2000 g
EW 12000-1NM	5000 g



**Adjustment procedure:**

Check that the surrounding conditions are stable.

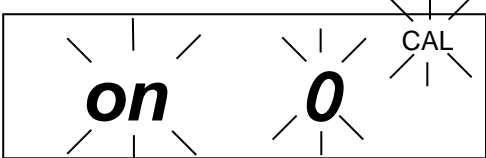
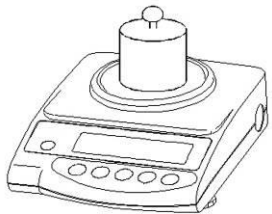
A short warm-up time of about 10 minutes is recommended for stabilisation.

Operation	Display
<p>Switch on the balance using the  key</p> <p>Press and hold the  key until [ <b>CAL</b> ] appears. Now release the key.</p>	<div style="border: 1px solid black; padding: 10px; text-align: center;"> <p><b>Func</b></p> <p>↓</p> <div style="border: 1px solid black; padding: 10px; text-align: center;"> <p><b>CAL</b></p> </div> </div>
<p>Press the  key while holding down the  key. Subsequently release both keys simultaneously.</p> <p style="text-align: center;">↓</p> <p>The zero point will be stored.</p>	<div style="border: 1px solid black; padding: 10px; text-align: center;">  <p>↓</p> <div style="border: 1px solid black; padding: 10px; text-align: center;"> <p><b>on F.S</b> <sup>CAL</sup></p> </div> </div>
<p>Place the adjusting weight carefully on the centre of the weighing plate.</p> <div style="text-align: center; margin: 20px 0;">  </div> <p>Display flashing [ <b>on F.S</b> ] then a moment later the weight value of the adjusting weight will be indicated. Remove the adjusting weight, the adjusting is terminated. The balance will automatically return to weighing mode. In case of an adjusting error or a wrong adjusting weight [ <b>- Err</b> ] appears in the display, repeat the adjustment procedure.</p>	<div style="border: 1px solid black; padding: 10px; text-align: center;">  <p>↓</p> <div style="border: 1px solid black; padding: 10px; text-align: center;"> <p><b>buSY</b> <sup>CAL</sup></p> <p>↓</p> <div style="border: 1px solid black; padding: 10px; text-align: center;"> <p><b>200.000 g</b></p> </div> </div> </div>

## 5.9 Verification

### General:

According to the EU guideline 2014/31/EU balances must be verified if they are to be used as follows (legally regulated area):

- a) For commercial transactions if the price of goods is determined by weighing
- b) For the production of medicines in pharmacies as well as for analyses in the medical and pharmaceutical laboratory
- c) For official purposes
- d) For the production of finished packages

In case of doubt, please contact your local office of weights and measures.

### Verification information

An EU qualification approval is available for those balances marked as appropriate for verification in the technical data. In the event that the balance is applied in an area subject to verification as described above, it must be verified and re-verified at regular intervals.

Re-verification of a balance is carried out in compliance with the respective legal provisions of the states. The term of verification validity for balances in Germany, for example, is normally 2 years.

The legal provisions of the country of use are to be observed.

## 5.10 Verification switch and official seal

Prior to verification the verification switch must be moved from the displayed position (see direction of arrow) to verification position. Once in this position, a parenthesis will be displayed around the last display point.

Following calibration the balance is sealed at the marked position.

**Balance calibration is not valid without the “official seals”.**

Position of the “official seals”:

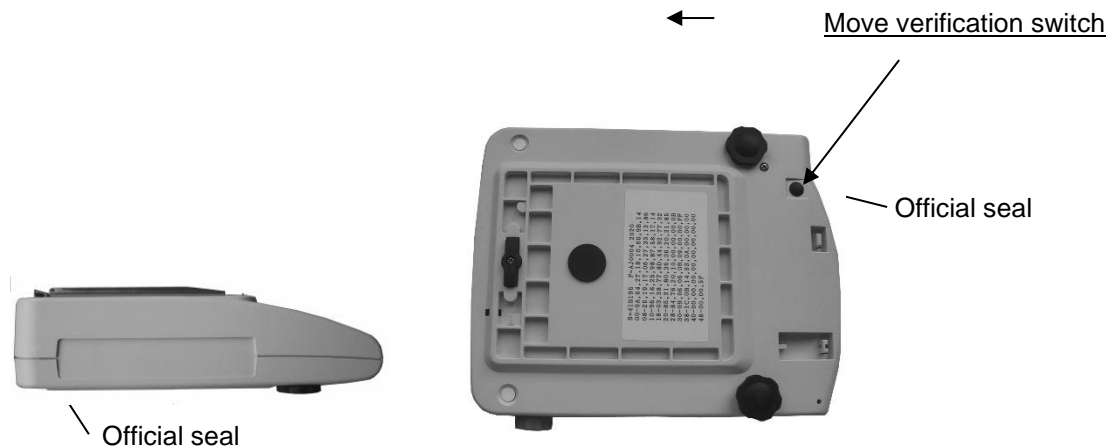

**Balances that are subject to compulsory verification must be taken out of operation if:**

- The **weighing result** of the balance is outside the **error limit**. Therefore, apply a known test weight (approx. 1/3 of the nominal load) to the balance at regular intervals and compare with the display value.
- The **reverification deadline** has been exceeded.



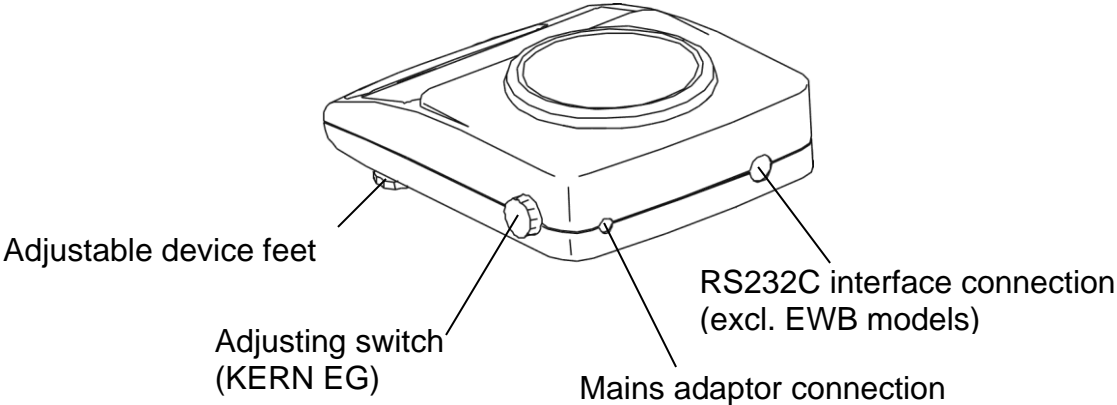
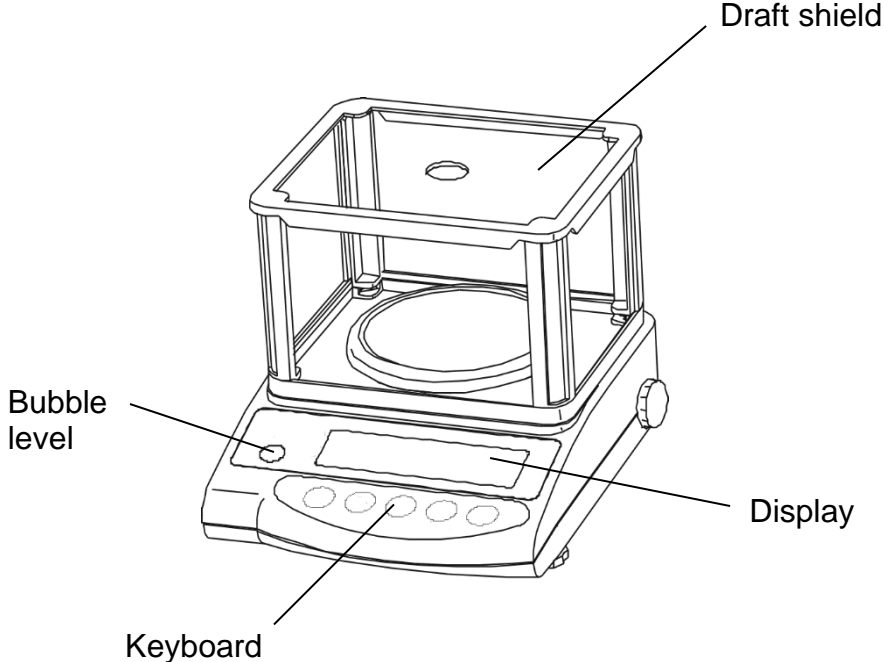

# 6 Operation

## 6.1 Operating elements

English

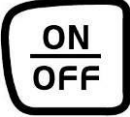

### 6.1.1 Overview of the keypad

Choice	Function
	<ul style="list-style-type: none"> <li>• Switch on and off</li> </ul>
	<ul style="list-style-type: none"> <li>• Output of weight value on an external device (printer) or PC</li> <li>• Save the respective mode settings (unit counter, percent weighing, tolerance weighing)</li> </ul>
	<ul style="list-style-type: none"> <li>• Unit counter and percent mode: Choice menu for unit and %</li> <li>• Save function parameters</li> <li>• Call up lower and upper tolerance levels</li> </ul>
	<ul style="list-style-type: none"> <li>• Key to alter the weight unit (g, ct, Pcs, %)</li> <li>• Entry of lower and upper tolerance levels</li> <li>• Choosing the function values within the function</li> <li>• Call up individual functions (multiple print)</li> <li>• Call up adjusting functions (permanent print)</li> <li>• The entry point is moved to the left each time by one step (chap. 6.2.4.3).</li> </ul>
	<ul style="list-style-type: none"> <li>• Tare or set weight display to zero</li> </ul>

## 6.1.2 Overview of display









Display	Description
g	Gramme
→0←	Zero setting display
o	Stability indication
*	Power display (standby)
Pcs	Unit counter display (excl. EW 120-4NM)
%	Percent weighing display (excl. EW 120-4NM)
◀	Tolerance weighing display (excl. EW 120-4NM)
mom	Momme
M	Balance carry out balance function, e.g. unit count / display of stored value
CAL	Calibration display. Signalises calibration procedure.
<b>0</b> <b>F</b>	Bar graph
Indication of weighing units	[ct] (ct) carat
	[oz] (oz) ounce
	[lb] (lb) pound
	[oz t] (ozt) fine ounce
	[dwt] (dwt) penny weight
	[▶ (upper right)] grain
	[tl] (tl) Tael (Hong Kong)
	[tl ▶ upper right] (tl ▶ upper right) Tael (Singapore, Malaysia)
	[tl ▶ lower right] (tl ▶ lower right) Tael (Taiwan)
	[to] (to) Tola
	Rechargeable battery mode (optional). [] Display changes to mains-powered mode if the voltage falls below the prescribed minimum.

## 6.2 Operation

### 6.2.1 Weighing

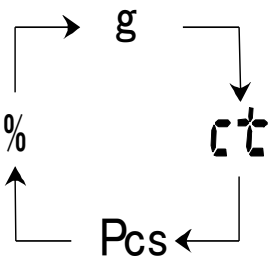
Display symbol: g

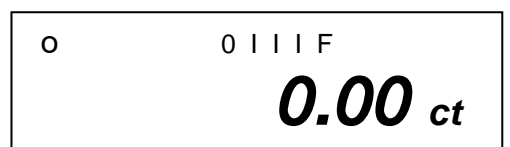
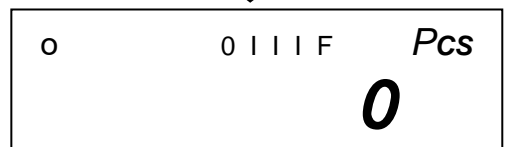
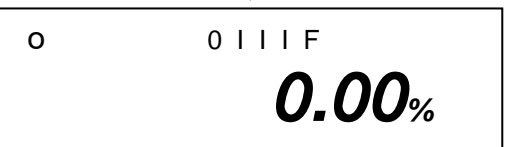
Operation	Display
<p>Press the  key to switch on the balance. The balance will carry out a self-test.</p>	
<p>Your balance is ready to weigh as soon as the "0.000" display appears. Apply the item to be weighed. The weight value is displayed.</p>	 <p style="text-align: center;">↓</p>
<p>A switch can be made from one unit to another, e.g. from "g" to another unit, for example "ct", by repeatedly pressing the  key. Setting – see <b>chapter 7</b> on "Functions". [g] → [ct] → [Pcs] → [%] → [g] → .....</p> <div style="text-align: center; margin: 20px 0;">  </div> <p>Press the  key to switch the balance off.</p>	 <p style="text-align: center;">↓</p>  <p style="text-align: center;">↓</p> 

### 6.2.1.1 Underfloor weighing

Objects which, because of their size or shape, cannot be put on the scale, can be weighed by means of underfloor weighing.

Proceed as follows:

- Switch off the balance.
- Turn the balance over.
- Open the cover plate (1) on the base of the balance.
- Hang on the hanging loop (optional) completely for underfloor weighing.
- Place the balance over an opening.
- Hang the item to be weighed on the hanging loop and carry out weighing.

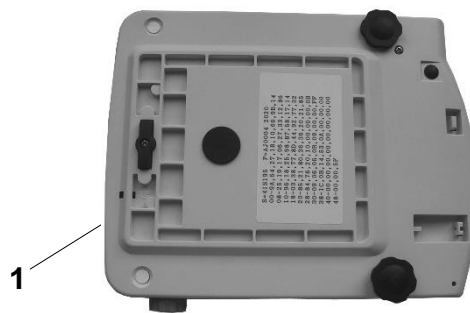

#### CAUTION

Take care that the hooks used for the underfloor weighing are stable enough to hold the goods which you wish to weigh (risk of breakage).

Always make sure that there are no living beings or materials below the load that could be injured or damaged.







#### NOTE

After completing the underfloor weighing, the opening in the floor of the balance must be closed again (dust protection).



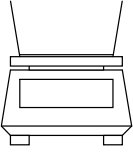

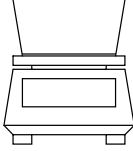
### 6.2.1.2 Tare weighing (tare)

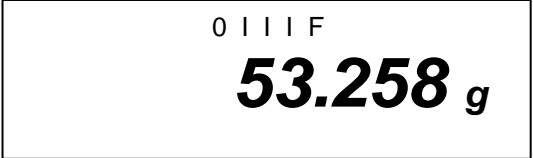
The empty weight of any weighing container can be tared at the push of a button, so that the net weight of the item to be weighed is displayed during subsequent weighings.

Operation	Display
<p>Place the empty tare container on the weighing plate. The total weight of the applied container is displayed.</p> 	
<p>Press the  key to start the tare procedure.</p>  <p>The weight of the container is now stored internally.</p>	
<p>Place the items to be weighed in the tare container.</p>  <p>Now read off the weight of the items on the display.</p>	

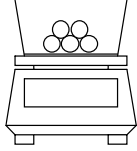
The tare procedure can be repeated as often as desired, for example when weighing several components into a mixture (weighing in).

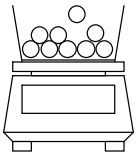
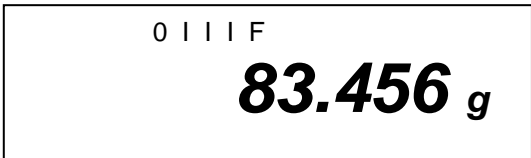
<p>Press the  key to set the display to "0.000".</p>  <p>The total weight of the container is removed by taring.</p>	
<p>Apply further components to the weighing container (weighing in).</p>  <p>Now read off the weight of the added item to be weighed on the display.</p>	

### Information:

The balance is only ever able to store one tare value.

The stored tare value is displayed prefixed by a minus sign when the balance is empty.

Remove all items from the weighing plate in order to delete the stored tare value and subsequently press the  key.

The tare procedure can be repeated as often as desired. The limit has been reached when the entire weighing range is used to full capacity.

## 6.2.2 Piece counting (excl. model KERN EW120-4NM)

### Display symbol: PCS







When counting units you can either count items into or out of the container. In order to be able to count a substantial number of items, the average weight per item must be determined using a small quantity (reference units).

The greater the reference unit, the greater the counting accuracy.

A particularly high reference must be chosen for small or greatly varying parts.

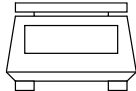
The work cycle is divided into four stages:

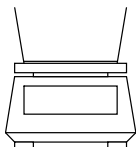
- Tare the weighing container
- Determine the reference unit
- Weigh in the reference unit
- Count the items

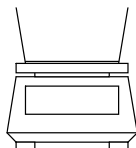
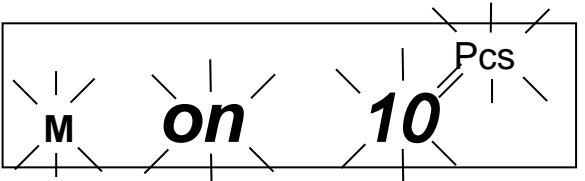
Operation	Display
<p>1. Use the  key to switch the balance on. Use the  key to select unit change-over <b>Pcs</b> (see chap. 6.2.2).</p> 	
<p>2. Tare containers can also be used during unit counting. Before starting unit counting use the  key to tare out the container.</p> 	
<p>3. Operate the  key. The reference unit will flash on the display.</p> 	

4. Further reference units of 10, 30, 50 and 100 can be called up by repeatedly

operating the  key.  
Important: The greater the reference unit, the more accurate the unit count.

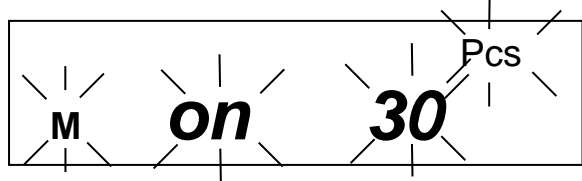
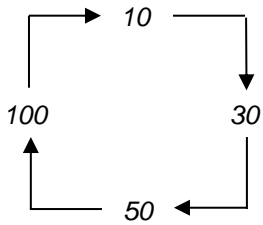

5. Place as many items to be counted on the balance as required by the set reference unit.

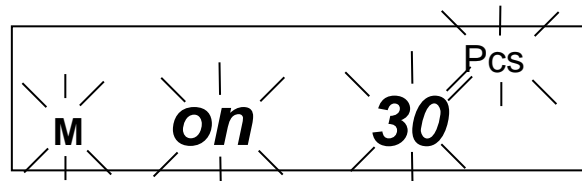
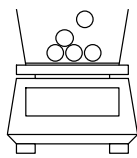

6. Operate the  key.  
The reference unit is stored.

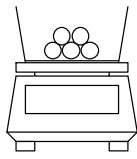

Now place the items to be counted in the container. The appropriate number of items will be shown on the display.

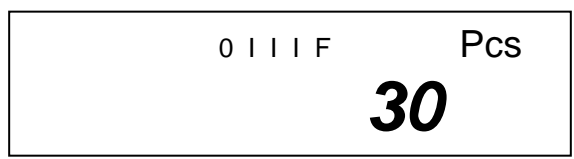

7. Use the  key to return to the desired weighing mode.

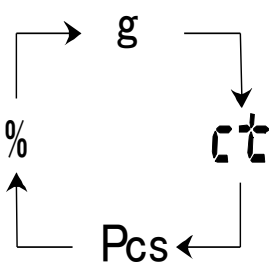





**Information:**



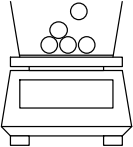
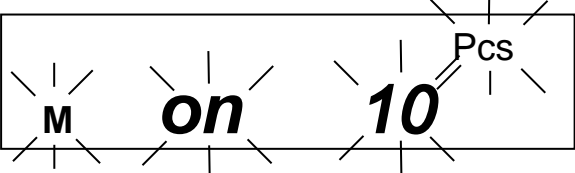

If the "L-Err" error message is displayed, the smallest counting weight has been fallen short of – see chap. 1 "Technical Data".

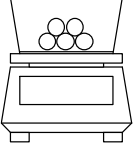
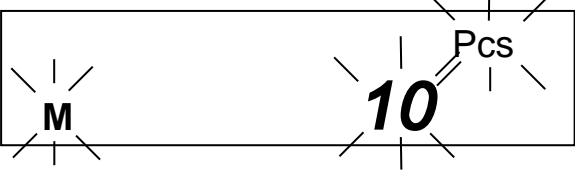
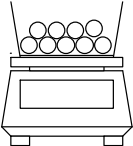
### 6.2.2.1 Add mode

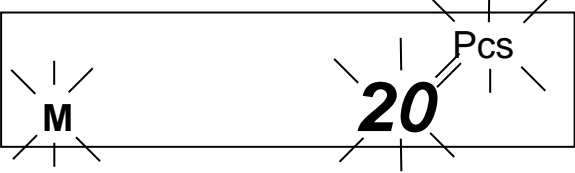
This function is used to increase the counting accuracy by increasing the reference quantity. It can thereby be avoided that an inadequate reference unit is used, as this could lead to inaccurate results.

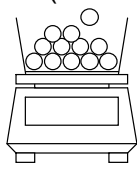
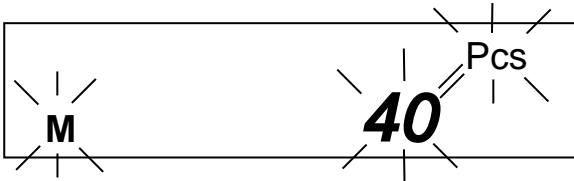
When applying this function, the necessary minimum number of items is automatically ensured.

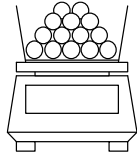
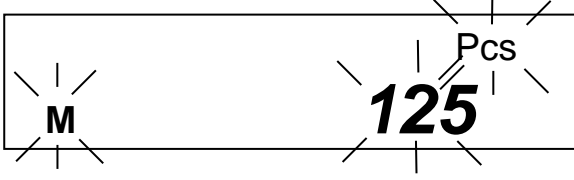
Operation	Display
<p>1. Carry out item 1-5 as in chap. 6.2.2 "Parts counter".</p>  <p>e.g. place 10 items on the weighing plate.</p>	
<p>2. Operate the  key. The reference weight of the 10 items is stored.</p>  <p>Counting accuracy can be increased by carrying out the following steps.</p>	
<p>3. Doubling the items to be weighed: Apply a further 10 items (approx.).</p>  <p>Operate the  key. The reference weight of the 20 items is stored.</p>	

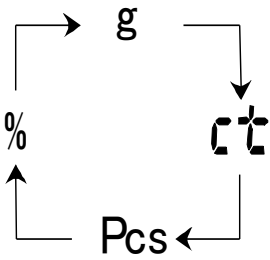
<p>4. Double again (see item 3)</p>  <p>Information: Every additionally applied number of items increases the reference and improves the counting accuracy. A particularly high quantity of reference units must be chosen for small items or items with greatly varying own weight.</p>	
<p>5. Operate the  key. The reference unit is stored.</p>  <p>Now place the items to be counted in the container. The appropriate number of items will be shown on the display</p>	
<p>Use the  key to return to the desired weighing mode.</p> 	











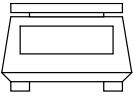

**Information:**

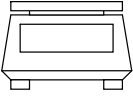

- If the “**Add**” error message appears, the applied number of items is too small for correct determination of the reference. Place further items on the balance to determine the reference.
- The determined reference is preserved until the balance is disconnected from the mains.

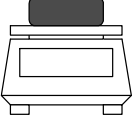
### 6.2.3 Percent weighing (excl. model KERN EW120-4NM)

#### Display symbol: %

Percent weighing allows the weight to be displayed as a percentage in relation to a reference weight. The displayed weight value is adopted as a fixed prescribed percent value. (Standard setting: 100%).

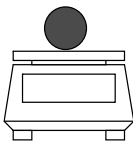
Operation	Display
<p>1. Use the  key to switch the balance on. Use the  key to select unit change-over [ % ] (see chap. 6.2.1).</p>  <p>Information: Tare containers can also be used during percent weighing. Before starting percent weighing use the  key to tare out the container.</p>	
<p>2. Operate the  key. [P. SEt] will flash on the display.</p> 	
<p>3. Place the reference weight = 100% in the balance dish.</p> 	
<p>4. Operate the  key. The reference weight is stored.</p> 	

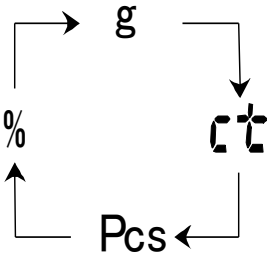
<p>From now on the applied weight is shown as a percentage.</p>  <p>Use the  key to return to the desired weighing mode.</p> 	<div style="border: 1px solid black; padding: 10px; text-align: center;"> <p>0 1 1 1 F</p> <p><b>85.37</b> %</p> </div>
--	---

#### Information:

- If the “**o-Err**” error message appears:
  - the reference weight is outside the weighing range (see **chap. 1** “Technical Data”).
  - the set key was operated during step 2 when the weight had been applied.
- The 100% reference is preserved until the balance is disconnected from the mains.

#### 6.2.4 Weighing using a tolerance range (excl. model KERN EW120-4NM)







This balance can be used as a measuring and sorting balance, whereby the respective lower and upper tolerance limits are programmable.

Limit values can be entered in the following operating modes:

- Weighing
- Unit counting
- Percent weighing



### 6.2.4.1 Basic settings when weighing using a tolerance range







Operation	Display
<p>1. Use the  key to switch the balance on.</p> <p style="text-align: center;">↓</p> <p>Call up the function menu: Press the  key until [<b>Func</b>] appears, then release.</p> <p style="text-align: center;">↓</p> <p>The first balance mode will appear:</p>	<div style="border: 1px solid black; padding: 5px; text-align: center;">  0 I I I F  <b>0.000 g</b> </div> <p style="text-align: center;">↓</p> <div style="border: 1px solid black; padding: 5px; text-align: center;"> <b>Func</b> </div> <p style="text-align: center;">↓</p> <div style="border: 1px solid black; padding: 5px; text-align: center;"> <b>1 b.G. 1</b> </div>
<p>2. Tolerance weighing Operate the  key to call up tolerance weighing mode. 2.SEL 0 (Off) 2.SEL 1 (ON)</p> <p>Use the  key to change the standard factory configuration.</p>	<div style="border: 1px solid black; padding: 5px; text-align: center;"> <b>2.SEL 0</b> </div> <p style="text-align: center;">↓</p> <div style="border: 1px solid black; padding: 5px; text-align: center;"> <b>2.SEL 1</b> </div>
<p>3. Tolerance mark display Operate the  key. The tolerance mark is always displayed (factory setting).</p> <p style="text-align: center;">↓</p> <p>Use the  key to change the setting (1 / 2).</p> <p>The tolerance mark is only displayed when the balance display is at a standstill.</p>	<div style="border: 1px solid black; padding: 5px; text-align: center;"> <b>+</b> 0 I I I F  <b>-</b> <b>0.000 g</b> </div> <p style="text-align: center;">↓</p> <div style="border: 1px solid black; padding: 5px; text-align: center;"> <b>21.Co. 2</b> </div>

<p>4. Setting the tolerance range Operate the <b>F</b> key</p> <p>The tolerance mark is displayed in all ranges.</p> <p style="text-align: center;">↓</p> <p>Use the <b>TARE →0←</b> key to change the setting:</p> <p>Tolerance mark is only displayed above a zero point range (+5).</p>	<div style="border: 1px solid black; padding: 5px; text-align: center;"> <p><b>+</b>      0 I I I F</p> <p><b>-</b>      <b>0.000 g</b></p> </div> <div style="border: 1px solid black; padding: 5px; text-align: center; margin-top: 10px;"> <p><b>22.L I. 1</b></p> </div> <p style="text-align: center;">↓</p> <div style="border: 1px solid black; padding: 5px; text-align: center; margin-top: 10px;"> <p><b>22.L I. 0</b></p> </div>
<p>5. Number of tolerance points Use the <b>F</b> key to set the tolerance mark.</p> <p>1 tolerance mark can be displayed:</p> <p style="margin-left: 20px;">■ ◀    too light</p> <p style="text-align: center;">↓</p> <p>Use the <b>TARE →0←</b> key to change the setting: 2 tolerance marks can be displayed:</p> <p style="margin-left: 20px;"><b>+</b> ◀    too heavy</p> <p style="margin-left: 20px;"><b>TOL</b>    target value</p> <p style="margin-left: 20px;">■ ◀    too light</p>	<div style="border: 1px solid black; padding: 5px; text-align: center; margin-top: 10px;"> <p><b>23.P I. 1</b></p> </div> <p style="text-align: center;">↓</p> <div style="border: 1px solid black; padding: 5px; text-align: center; margin-top: 10px;"> <p><b>23.P I. 2</b></p> </div>
<p>Operate the <b>5</b> key: You will now leave the function menu and return to weighing mode.</p>	<div style="border: 1px solid black; padding: 5px; text-align: center; margin-top: 10px;"> <p>0            0 I I I F</p> <p><b>0.000 g</b></p> </div>

## 6.2.4.2 Entering the limit values by weighing

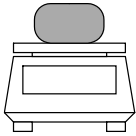
### Important information !

Always begin by entering the lower limit value, followed by the upper limit value.

Operation	Display
<p>1. Use the  key to switch the balance on.</p> <p style="text-align: center;">↓</p> <p>Set to tolerance weighing: Press the  key until [<b>L. SEt</b>] appears and then release.</p>	<div style="border: 1px solid black; padding: 5px; text-align: center;">  0 I I I F  <b>0.000 g</b> </div> <p style="text-align: center;">↓</p> <div style="border: 1px solid black; padding: 5px; text-align: center;"> <b>L. SEt</b> </div>
<p>2. The tolerance mark ◀ will flash [ - ]. The lower limit value can be set.</p> <p>Place a sample for the lower (i.e. smaller) limit value on the weighing plate:</p> <div style="text-align: center;">  </div> <p>Store using the  key. The stored lower weight value is displayed briefly. Entry is now completed if 1 tolerance mark was selected in the basic setting (see chap. 7.2.1).</p>	<div style="border: 1px solid black; padding: 5px; text-align: center;">  <b>0.000 g</b> </div>  <div style="border: 1px solid black; padding: 5px; text-align: center;">  <b>93.835 g</b> </div>

4. If 2 tolerance marks have been selected, the upper limit value must now be determined.

The tolerance mark ◀ is flashing [ + ], and the upper limit value can be set.

Place a sample for the upper (i.e. larger) limit value on the weighing plate:



***H. SEt***



M

***0000 g***











5. Use the  key to store. The stored upper weight value is displayed briefly; entry is completed.

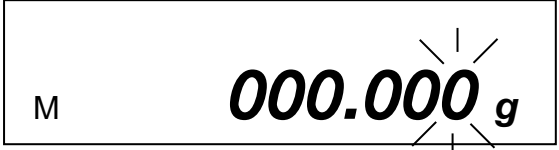

M

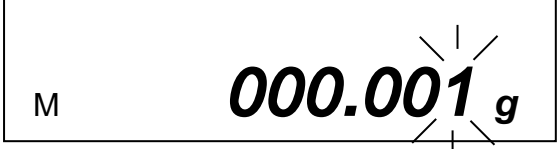
***158.487 g***

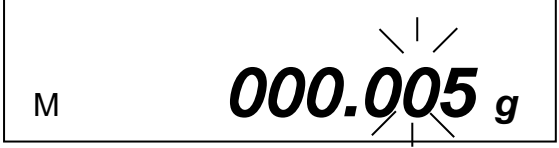
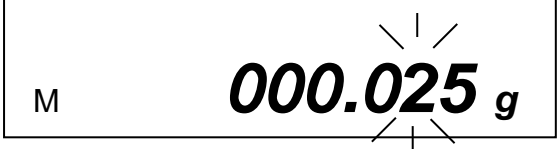
### 6.2.4.3 Entering the limit values using the keyboard

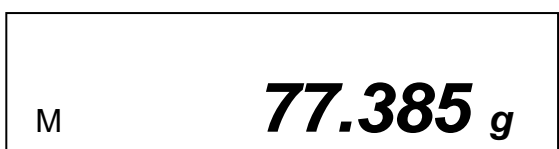
Operation	Display
<p>1. Use the  key to switch the balance on.</p> <p style="text-align: center;">↓</p> <p>Set tolerance weighing: Press the  key until <b>[L. SEt]</b> appears and then release.</p>	<div style="border: 1px solid black; padding: 5px; text-align: center;">  </div> <p style="text-align: center;">↓</p> <div style="border: 1px solid black; padding: 5px; text-align: center;">  </div>
<p>2. Flashing display is either 000.000 or the currently stored lower limit value. Press the  key: The last digit in the display starts to flash.</p>	<div style="border: 1px solid black; padding: 5px; text-align: center;">  </div>
<p>3. Use the  key to increase the numerical value of the selected digit.</p>	<div style="border: 1px solid black; padding: 5px; text-align: center;">  </div>
<p>4. Use the  key to select the digit you wish to alter (from right to left).</p>	<div style="border: 1px solid black; padding: 5px; text-align: center;">  </div>
<p>5. Further entries as described in items 3 and 4.</p>	<div style="border: 1px solid black; padding: 5px; text-align: center;">  </div>
<p>6. Use the  key to store. The stored lower weight value is displayed briefly.  Entry is now completed if 1 tolerance mark was selected in the basic setting (chap. 7.2.1).</p>	<div style="border: 1px solid black; padding: 5px; text-align: center;">  </div>

7. If 2 tolerance marks have been selected, the upper limit value must now be determined.

Please proceed as described in item 2, starting with the last display digit.

***H. SEt***



M

***000.000 g***











8. Enter the upper limit value and store.

## 7 Functions

### 7.1 Access and changing of numerous functions:



The balance has been set to a certain standard configuration in the factory. This configuration is marked by a ☆.

The configuration can be changed as follows:

Operation	Display
1. Access to the functions.	
Switch on the balance:  ↓	
Press the  key for about 4 seconds until <b>[FUNC]</b> appears:  ↓	
When released the following will appear : (possible configurations are listed in chap. 7.2.2).  ↓	
2. Changing the functions Run through the various functions for configuration by continuing to press the  key.  ↓	
Operate the  key in order to change the last position in the parameter.  ↓	
Store the chosen function by operating the  key. You will now leave the function menu and return to weighing mode.	

## 7.2 List of the function parameters

The balance has been set to a certain standard configuration in the factory. This is marked by a ☆.



Function	Display 		Choice 	Description of the choice possibilities
Bar graph	1	b.G.	0	Off
			☆1	On
Tolerance weighing (excl. EW-120-4NM)	2	SEL	☆0	Off
			1	On (chap. 7.2.1)
Only displayed when tolerance weighing is active:				
Weighing with a tolerance range Precondition	21.	C0.	☆1	Checked also when the balance is unstable
			2	Checked also when the balance is stable
Weighing with a tolerance range Range	22.	Li.	0	Checked also when the balance is stable
			☆1	The entire range is checked (including negative values)
Number of adjustment points for tolerance weighing	23.	Pi.	1	Single point setting (the range between OK and LO is checked)
			☆2	Values above the upper limit and values below the lower limit are configurable (i.e. range between HI, OK and LO)
Zero alignment	3	A.0	0	No zero point correction
			☆1	Automatic zero point correction activated.
Automatic shutoff after 3 min. for rechargeable battery operation (function is only available in rechargeable battery mode)	4	A.P.	0	Automatic shutoff deactivated for rechargeable battery operation (optional).
			☆1	Automatic shutoff activated for rechargeable battery operation (optional).
Display speed	5	rE.	0	Setting for metering
		↓	1	Sensitive and fast
			2	↓
			☆3	↓
			4	↓
			5	Non-sensitive but slow
Vibratory filter	6	S.d.	1	Sensitive and fast (very tranquil installation location).
			☆2	↓
			3	↓
			4	Non-sensitive but slow (very unsettled installation location).
			5	only EW-120-4NM
			6	only EW-120-4NM



Interface (excl. EWB models)  Weight unit (only selectable, if the calibration switch is not in the calibration position see Ch. 5.10)	7          81 ↓ 85	I.F.          S.u.	0	Interface not active
			☆3	6-digit data format
			4	7-digit data format
			1☆01	(g)
			2☆14	(ct)
			15	(oz)
			16	(lb)
			17	(ozt)
			18	(dwt)
			19	(grain), (excl. EWB models)
			1A	(tl Hong Kong)
			1b	(tl Singapore, Malaysia)
			1C	(tl Taiwan)
1d	(mom)			
1E	(to)			
3☆20	(Pcs) excl. EW-120-4NM			
4☆IF	(%) excl. EW-120-4NM			
5☆00	Unit not set (can not be set at 81.S.u.)			
Not documented	9.	Ai	0	Not documented
Extended printout of the calibration protocol (function selectable in EG models only)	0.	GLP	☆0	OFF
			☆1	ON  <div style="border: 1px solid black; padding: 5px; display: inline-block;"> <p><b>**CALIBRATION**</b>  MODEL:  S/N:  ID:  DATA:  TIME:  *CAL. END  NAME  *****</p> </div> <div style="display: inline-block; vertical-align: top; margin-left: 20px;"> <p>Header  Model  Serial no.  ID no.  Calibration date  Calibration time  End of calibration  Name of person  checking</p> </div>
Data output (only selectable, if the calibration switch is not in the calibration position, see Ch. 5.10)	A.	PrF.	1	No printout possible if the last display location is enclosed in brackets.
			☆2	Printout possible even if the last display location is enclosed in brackets. Note: Always select this setting before balance calibration because this menu item can no longer be called up after calibration
			3	Printout possible only when the calibration switch is not in the calibration position, see Ch. 5.10.



## 7.2.1 Parameters when weighing with a tolerance range (excl. model KERN EW120-4NM)

Settings 21. Co. to 23. P I. can only be set if the tolerance weighing function has been activated.









Function		Display 	Choice 	Description of the choice possibilities
Display conditions of the tolerance mark	21.	Co.	☆1	Tolerance mark is always displayed, even if standstill check not yet indicated.
		↓	2	Tolerance mark only displayed in connection with standstill check.
Tolerance range	22.	L I.	0	Tolerance mark only displayed above the zero point range (at least + 5).
			☆1	Tolerance mark displayed throughout entire range.
Setting the tolerance mark	23.	P I.	1	1 tolerance step is displayed: “-“ or “+”
		↓	☆2	2 tolerance steps are displayed: “- “ and “+”

## 7.2.2 Parameters for the serial interface

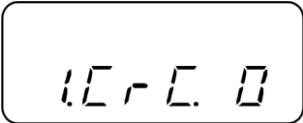
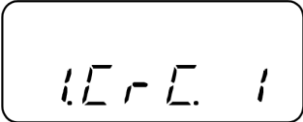
(excl. EWB models)

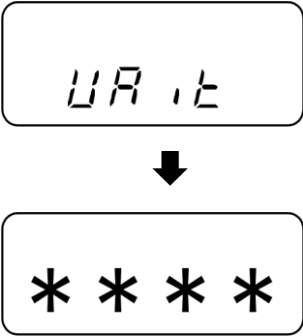
Function	Display	Choice	Description of the choice possibilities
			
Output format at interface	7 I.F. ↓	0 ☆1 2	Interface not active 6-digit data format 7-digit data format
Output condition at interface (Menu setting "7 I.F. [1] or [2]" only )	71. o.c. ↓	0 1 2 3 4 5 6 ☆7	No data issued. Continuous serial output. Continuous serial output upon stabilised display. Output following printing of PRINT/M. Automatic output upon stable weighing value. The first value to stabilise is adopted if this is -0.00 or less. No new output until weight is removed and a new load applied. Output upon stabilisation, no output if data unstable. Output upon stabilisation, constant output if data unstable. Output following printing of PRINT/M.
Baud rate	72. b.L.	☆1 2 3 4	1200 bps 2400 bps 4800 bps 9600 bps
Parity (Menu setting "7 I.F. 2" only )	73. PA.	☆0 1 2	No parity bit Uneven parity Even parity

### 7.2.3 Show software status

	Press  and the  at the same time and keep them pressed until „Func2“ will be displayed.
	When released, „1.CrC. 0.“ is displayed.
	Use  to select the setting „1.CrC. 1.“
	Press  . Wait until the software status of the balance is displayed.
	<b>Return to weighing mode:</b> Press  or  .

## 8 Data output

(excl. EWB models)

The balance is supplied as standard with an interface RS 232C.

### 8.1 Description of the serial data output (RS 232C)

The data output is placed at the rear side of the balance. It is a 5-pole standard socket.

Pin description see following illustration

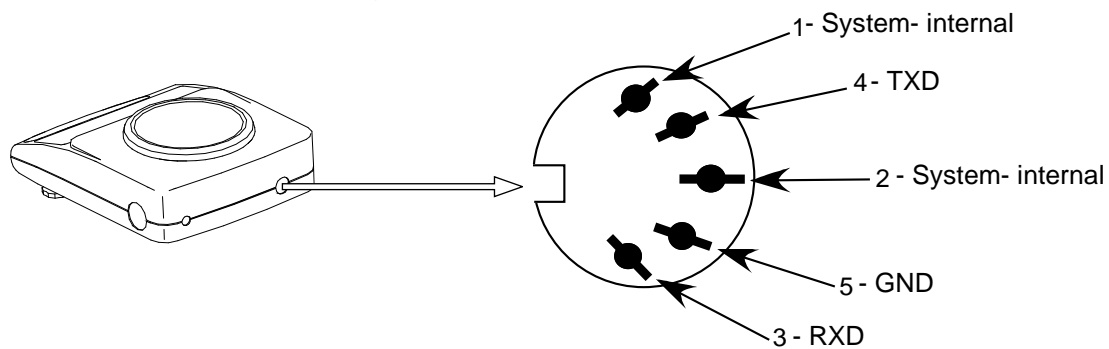

### 8.2 Technical data of the interface

Transfer format: serial data transfer

Data-bit: 8-bit (Standard-ASCII-Format)

Start-bit: 1 bit

Stop-bit: 2 bits

Parity: NON, ODD, EVEN

Baudrate: 1200 / 2400 / 4800 / 9600 baud can be set  
(see chap. 7.2.2 "Functions")

### 8.3 Interface description

The output format, output control, transfer speed and parity bit can be set following the choice of a certain operating mode. The various possibilities are described in **chap. 7.2.2** "Parameters for the serial interface".

### 8.4 Data Output

#### 8.4.1 Data Transmission Formats

By selecting the corresponding function at your balance one of the two following data formats can be set:

- **6-digit data format**  
(excl. model KERN EW-120-4NM)

Consisting of 14 words including the final signal; CR=0DH, LF=0AH (CR=return travel / LF=line feed)

<b>1</b>	<b>2</b>	<b>3</b>	<b>4</b>	<b>5</b>	<b>6</b>	<b>7</b>	<b>8</b>	<b>9</b>	<b>10</b>	<b>11</b>	<b>12</b>	<b>13</b>	<b>14</b>
P1	D1	D2	D3	D4	D5	D6	D7	U1	U2	S1	S2	CR	LF

- **7-digit data format**

<b>1</b>	<b>2</b>	<b>3</b>	<b>4</b>	<b>5</b>	<b>6</b>	<b>7</b>	<b>8</b>	<b>9</b>	<b>10</b>	<b>11</b>	<b>12</b>	<b>13</b>	<b>14</b>	<b>15</b>
P1	D1	D2	D3	D4	D5	D6	D7	D8	U1	U2	S1	S2	CR	LF

**Note:** The 7-digit format is identical with the 6-digit format except for the additional signal D8.

#### Calibration mark data format

The calibration mark "/" is used to mark the following positions as "non-calibrated".

- **6-digit data format**

6-digit data format for the selection of "A.PrF.3" (Printout possible only when the calibration switch is not in the calibration position, see Ch. 5.10.)

Consisting of 15 words including the final signals; CR=0DH, LF=0AH and the calibration mark "/".

<b>1</b>	<b>2</b>	<b>3</b>	<b>4</b>	<b>5</b>	<b>6</b>	<b>7</b>	<b>8</b>	<b>9</b>	<b>10</b>	<b>11</b>	<b>12</b>	<b>13</b>	<b>14</b>	<b>15</b>
P1	D1	D2	D3	D4	D5	D6	D7	D8	U1	U2	S1	S2	CR	LF

- **7-digit data format**

7-digit data format for the selection of "A.PrF.3" (Printout possible only when the calibration switch is not in the calibration position, see Ch. 5.10.)

Consisting of 16 words including the final signals; CR=0DH, LF=0AH and the calibration mark "/".

<b>1</b>	<b>2</b>	<b>3</b>	<b>4</b>	<b>5</b>	<b>6</b>	<b>7</b>	<b>8</b>	<b>9</b>	<b>10</b>	<b>11</b>	<b>12</b>	<b>13</b>	<b>14</b>	<b>15</b>	<b>16</b>
P1	D1	D2	D3	D4	D5	D6	D7	D8	D9	U1	U2	S1	S2	CR	LF

### 8.4.2 Algebraic sign

P 1 = 1 word

<b>P 1</b>	<b>Code</b>	<b>Meaning</b>
+	2 B H	Data are 0 or positive
-	2 D H	Data are negative
sp	20 H	Data are 0 or positive

### 8.4.3 Data

D 1 to D 7 7 words with 6-digit format (excl. model KERN EW-120-4NM)

D 1 to D 8 8 words with 7-digit format

<b>D *</b>	<b>Code</b>	<b>Meaning</b>
0 - 9	30 H – 39 H	Data 0 to 9 (max. 6 characters in 6-type format)
. (Point)	2 EH	Decimal point, position not fixed
Sp	20 H	Space character, leading zero oppressed

#### 8.4.4 Units

U 1, U 2 = 2 words as ASCII codes

U1	U2	Code		Meaning	Symbol
(SP)	G	20H	47H	Gramme	g
C	T	43H	54H	Carat	ct
O	Z	4FH	5AH	Ounze	oz
L	B	4CH	42H	Pound	lb
O	T	4FH	54H	Fine ounce	oz t
D	W	44H	57H	Pennyweight	dwt
G	R	47H	52H	Grain	► (upper right)
T	L	54H	4CH	Tael (Hong Kong)	ti
T	L	54H	4CH	Tael (Singapore, Malaysia)	ti ► (upper right)
T	L	54H	4CH	Tael (Taiwan)	ti ► (lower right)
M	O	4DH	4FH	Momme	mom
t	o	74H	6FH	Tola	to
(SP)	%	20H	25H	Percent	% (excl. EW-120-4NM)
P	C	50H	43H	Quantity	Pcs (excl. EW-120-4NM)

#### 8.4.5 Result of the evaluation / Type of data

S 1 = 1 Word

S 1	Code	Meaning
L	4 CH	When weighing using tolerance range: Weighing value below the tolerance range
G	47 H	Weighing value within the tolerance range Result of the evaluation issued at two points: Low / high
H	48 H	Weighing value above the tolerance range

#### 8.4.6 Data state

S 2 = 1 Word

S 2	Code	Meaning
S	53 H	Stabilised data *
U	55 H	Data not stabilised (fluctuating) *
E	45 H	Data error, all data unreliable with the exception of S 2. Balance displays error (o-Err, u-Err)
sp	20 H	No special status



## 8.5 Data input commands

### 8.5.1 Command input format

is made up of 4 characters, CR=0DH, LF=0AH

1	2	3	4
C1	C2	CR	LF

### 8.5.2 External taring command

C1	C2	Code		Content
T	SP	54H	20H	Tare out command

### 8.5.3 External control commands

C1	C2	Code		Meaning
O	0	4FH	30H	No data output
O	1	4FH	31H	Continuous data output
O	2	4FH	32H	Continuous output of stable weight value data
O	3	4FH	33H	Output of stable and unstable weight values after pressing the PRINT button
O	4	4FH	34H	Data output upon stable weight value, having previously unloaded the weighing scale
O	5	4FH	35H	Data output upon stable weight value. No data output at unstable weight value. Data output again, after stabilization has been reached
O	6	4FH	36H	Data output upon stable weight value. Continuous data outputting at unstable weight value.
O	7	4FH	37H	Output of stable weight values after pressing the PRINT button
O	8	4FH	38H	One-time immediate data output*
O	9	4FH	39H	One-time data output after stabilization has been reached*
O	A	4FH	41H	One-time, immediate data output after lapse of a defined period of time*
O	B	4FH	42H	One-time, immediate data output after lapse of a defined period of time and upon stable weight value*

\* While using these commands for remote control purposes, do not press the PRINT button (data transmission error). In case data transmission error occurs, briefly cut off the weighing scale from its power supply source.

Remarks:

- Control of data output through “O0~O7” commands as well as setting up weighing scale’s functions, are actions that bring about similar effects.
- Implementation of commands “O8 and O9” is connected with data input commands.
- If any command from the “O0~O9” range has been carried out, then its status will remain active until the next command is inputted. If, however, the weighing scale is switched off, then the output data control system will return to its previous setup.

## 8.6 Feedback message after data transmission

is made up of 5 characters, CR=0DH, LF=0AH

1	2	3	4	5
A1	A2	A3	CR	LF

Types of feedback messages:

A1	A2	A3	Code			Description
A	0	0	41H	30H	30H	No errors
E	0	1	45H	30H	31H	Error message

## 9 Maintenance, upkeep, disposal

### 9.1 Cleaning

Please disconnect the device from the operating voltage before cleaning.

Only use a cloth dampened with mild suds and not aggressive cleaning agents (solvents or similar). Please ensure that fluids are not able to get into the device and rub off using a clean, soft cloth.

Loose sample residue/powder can be removed carefully using a brush or hand vacuum cleaner.

**Remove any spilt material to be weighed immediately.**

### 9.2 Maintenance, upkeep

The device may only be opened by trained service engineers authorised by KERN. Disconnect from the mains supply before opening.

### 9.3 Disposal

The operating company shall dispose of the packaging and the device in compliance with the valid national or regional law of the operating location.

## 10 Troubleshooting

The balance should be switched off for a short time following an interruption in the programme sequence and disconnected from the mains supply. It is then necessary to repeat the weighing process from the beginning.

Help:

<b>Interruption</b>	<b>Possible cause</b>
Weight display is not illuminated.	<ul style="list-style-type: none"><li>• The balance is not switched on.</li><li>• The mains supply connection has been interrupted (mains cable not plugged in/faulty).</li><li>• Power supply interrupted.</li></ul>
The weight display changes continually	<ul style="list-style-type: none"><li>• Draught/air movement</li><li>• Table/floor vibrations</li><li>• The weighing plate is in contact with foreign matter.</li><li>• Electromagnetic fields / static charging (choose different location/switch off interfering device if possible)</li></ul>
The weighing result is obviously incorrect	<ul style="list-style-type: none"><li>• The balance display is not set to zero</li><li>• Adjustment is no longer correct.</li><li>• Great fluctuations in temperature.</li><li>• Electromagnetic fields / static charging (choose different location/switch off interfering device if possible)</li></ul>

Switch the balance off if other error messages should appear and then switch on again. Contact the manufacturer if the error message does not disappear.

## 11 Declaration of Conformity

To view the current EC/EU Declaration of Conformity go to:

[www.kern-sohn.com/ce](http://www.kern-sohn.com/ce)

- i** The scope of delivery for verified weighing balances (= conformity-rated weighing balances) includes a Declaration of Conformity.